

VISIBLE LIGHT PRODUCTS SPECIFICATION

HPB8-49KYWG



High Power 1W LED

Drawn by	Checked by	Approved by



DATE:2009/6/1

REV:A

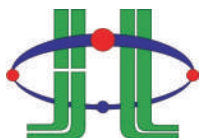

HUEY JANN ELECTRONICS INDUSTRY CO., LTD.

No.27 Line 466 Sec.2,Cannng-nan Rd. Wu-chi Town Taichung Shien, Taiwan, R.O.C.

TEL:+886-4-26393976 FAX:+886-4-26393125

HUEY JANN High Power 1W LED is made of hi-eff AS/TS AlInGaP and GaInN chips with precise package technique which makes excellent heat dissipation to reach the advantages of high luminous efficiency, low decay, and long endurance. Now we have these colors available: red, green, blue, white, yellow and infrared.

FEATERUS

- Instant light
- Long operating life
- Superior ESD defense
- Low voltage DC operated
- More energy efficient than incandescent and most halogen lamps

TYPICAL APPLICATIONS

- Architectural detail lighting
- Portable flashlight
- Reading lights
- Medical applications
- LCD backlights
- Beacon lights
- Decoration lights

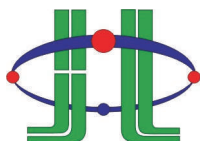

HUEY JANN ELECTRONICS INDUSTRY CO., LTD.

No.27 Line 466 Sec.2,Cannng-nan Rd. Wu-chi Town Taichung Shien, Taiwan, R.O.C.

TEL:+886-4-26393976 FAX:+886-4-26393125

DEVICES

Lens		Source	
Color	Diffusion	Dice Source	Color
Water Clear	Non-Diffusion	GaNN/GaN	Super Warm White

PACKAGE DIMENSIONS:

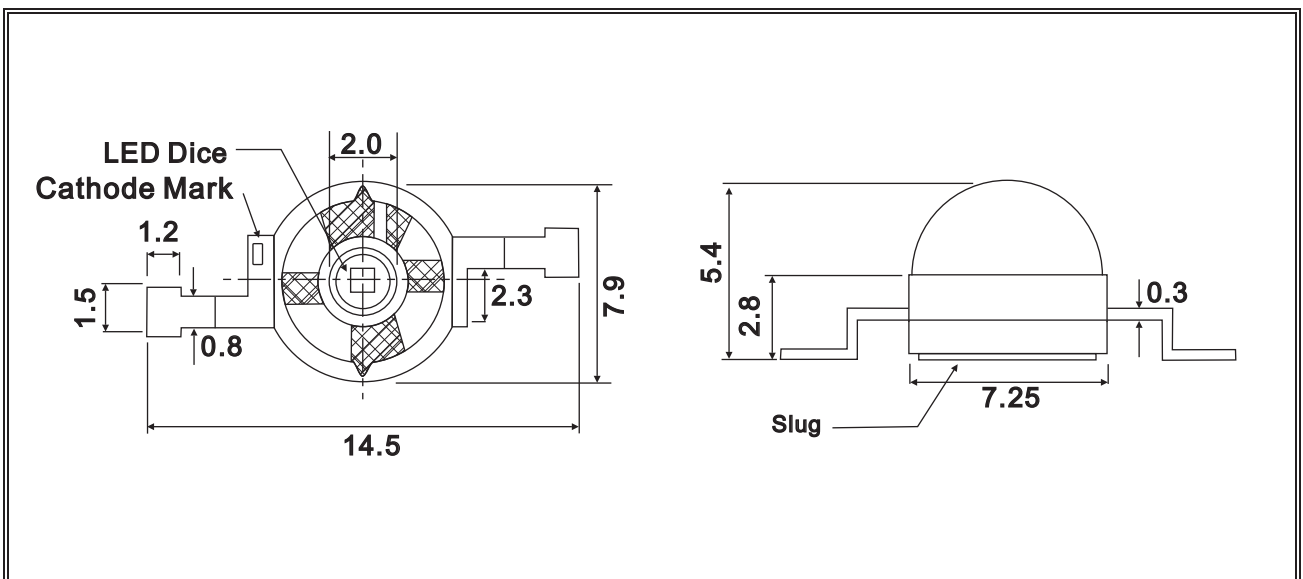

NOTE:

- 1.All dimensions are in millimeter.
- 2.Lead spacing is measured where the lead emerge from the package.
- 3.protruded resin under flange is 1.5mm max.
- 4.specifications are subject to change without notice.
- 5.Tolerance is ± 0.3 mm unless otherwise noted.
- 6.Driving LED without heat sinking device is forbidden.
- 7.It is strongly recommended that the temperature of lead be not higher than 55°C.
- 8.Proper current derating must be observed to maintain junction temperature below the maximum.
- 9.LEDs are not designed to be driven in reserve bias.

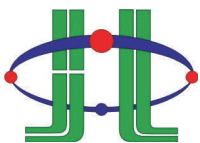

HUEY JANN ELECTRONICS INDUSTRY CO., LTD.

No.27 Line 466 Sec.2,Cannng-nan Rd. Wu-chi Town Taichung Shien, Taiwan, R.O.C.

TEL:+886-4-26393976 FAX:+886-4-26393125

ABSOLUTE MAXIMUM RATINGS

TA=25°C

PARAMETER	SYMBOL	MAX. RATING	UNIT
Continuous Forward Current	IF	350	mA
Peak Forward Current *1	IFM	500	mA
Electrostatic Discharge (HBM)	ESD	4000	V
LED Junction Temperature	Tj	135	°C
Operating Temperature	Topr	-40 ~ +110	°C
Storage Temperature	Tstg	-40 ~ +120	°C
Manual Soldering Temperature 260 °C for 5 seconds max. *2 *3			

*1.Duty Ratio=0.1%,Pulse Width=10us.

*2.Iron soldering high temperature will not cause damage to the dice. But be aware of the high temperature will not only make the epoxy soften but also cause the lead moving and the gold wire broken and even open. So before returning to the normal temperatures PLEASE AVOID any serious pressure on the top of epoxy and lead.

*3.Measured at leads, lens temperature must not exceed 120°C during lead soldering and slug attach. Soldering by general IR reflow, Vapor phase reflow and wave soldering on this system product is unsuitable. Selective heating of the leads limit lead soldering, such as by hot bar reflow, fiber focussed IR, or hand soldering. The package back plane (slug) may not be attached by soldering, but rather with a thermally conductive adhesive. Electrical insulation between the slug and the board is necessary. Please consult welding matters needing attention.

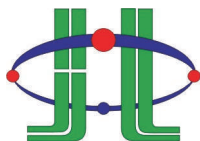

HUEY JANN ELECTRONICS INDUSTRY CO., LTD.

No.27 Line 466 Sec.2,Cannng-nan Rd. Wu-chi Town Taichung Shien, Taiwan, R.O.C.

TEL:+886-4-26393976 FAX:+886-4-26393125

ELECTRIC-OPTICAL CHARACTERISTICS

TA=25°C

PARAMETER	SYMBOL	TEST CONDITION	MIN	TYP	MAX	UNIT
View Angle of Half Power	2θ1/2	IF=350mA		120		deg
Forward Voltage	VF			3.5	4.0	V
Reverse Current	IR	VR=5V			15	μA
Luminous Intensity *2	IV	IF=350mA		95		lm
Color Temperature	CCT			3300		°K
Thermal Resistance Junction To Case	$R_{\theta J-C}$			15		°C/W
Temperature Coefficient Of Forward Voltage	$\Delta V_F / \Delta T$				-2	

*2.Tolerance:±15% measuring equipment :EXELTRON 2001.

*3.Correlated Color Temperature (CCT) ±5% tester tolerance.

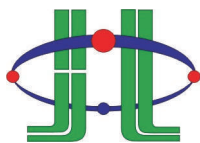

HUEY JANN ELECTRONICS INDUSTRY CO., LTD.

No.27 Line 466 Sec.2,Canng-nan Rd. Wu-chi Town Taichung Shien, Taiwan, R.O.C.

TEL:+886-4-26393976 FAX:+886-4-26393125

RELIABILITY TEST

Endurance Test

Test Item	Reference Standard	Test Conditions	Result
Operation Life	MIL-STD-750:1026 MIL-STD-883:1005 JIS-C-7021 :B-1	Connect with a power if=350mA Ta=Under room temperature Test Time=1,000hrs	0/22
High Temperature High Humidity Storage	MIL-STD-202:103B JIS-C-7021 :B-11	Ta=+85°C±5°C RH=80% ~ 85% Test Time=1,000hrs	0/22
High Temperature Storage	MIL-STD-883:1008 JIS-C-7021 :B-10	High Ta=+120°C±5°C Test Time=1,000hrs	0/22
Low Temperature Storage	JIS-C-7021 :B-12	Low Ta=-40°C±5°C Test Time=1,000hrs	0/22

*Failure Criteria:

1. VF arise $\geq 10\%$
2. IV decline $\geq 30\%$
3. A failure is an LED that is open or shorted

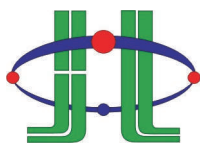

HUEY JANN ELECTRONICS INDUSTRY CO., LTD.

No.27 Line 466 Sec.2,Cannng-nan Rd. Wu-chi Town Taichung Shien, Taiwan, R.O.C.

TEL:+886-4-26393976 FAX:+886-4-26393125

RELIABILITY TEST

➤ Environmental Test

Test Item	Reference Standard	Test Conditions	Result
Temperature Cycling	MIL-STD-202:107D MIL-STD-750:1051 MIL-STD-883:1010 JIS-C-7021 :A-4	-40°C ~ +25°C ~ +85°C ~ +25°C 60min 20min 60min 20min Test Time=200cycle	0/22
Thermal Shock	MIL-STD-202:107D MIL-STD-750:1051 MIL-STD-883:1010	-40°C±5°C ~ +110°C±5°C 20min 20min Test Time=200cycle	0/22

*Failure Criteria:

1. VF arise \geq 10%
2. IV decline \geq 30%
3. A failure is an LED that is open or shorted

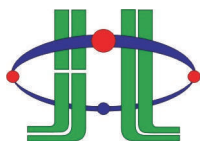

HUEY JANN ELECTRONICS INDUSTRY CO., LTD.

No.27 Line 466 Sec.2,Canng-nan Rd. Wu-chi Town Taichung Shien, Taiwan, R.O.C.

TEL:+886-4-26393976 FAX:+886-4-26393125

TYPICAL ELECTRICAL OPTICAL CHARACTERISTICS CURVES

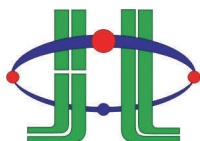
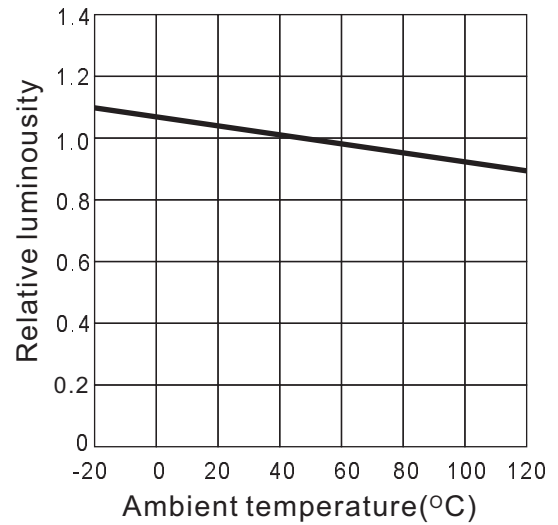
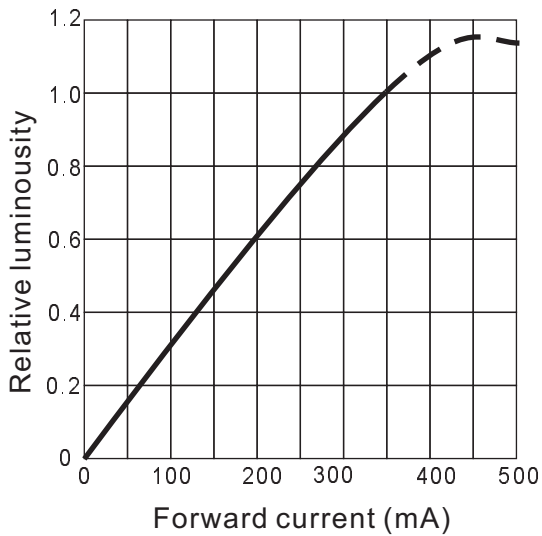
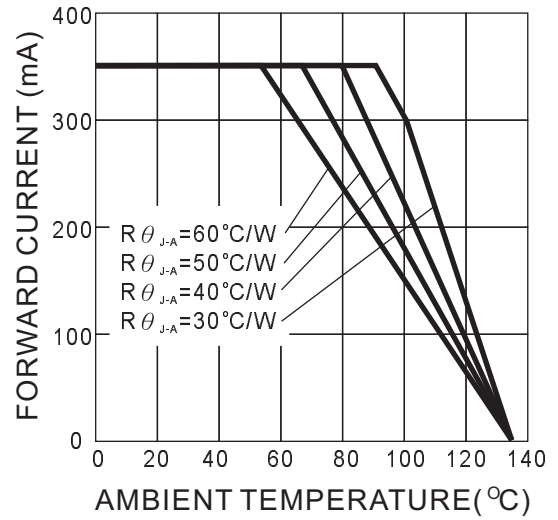
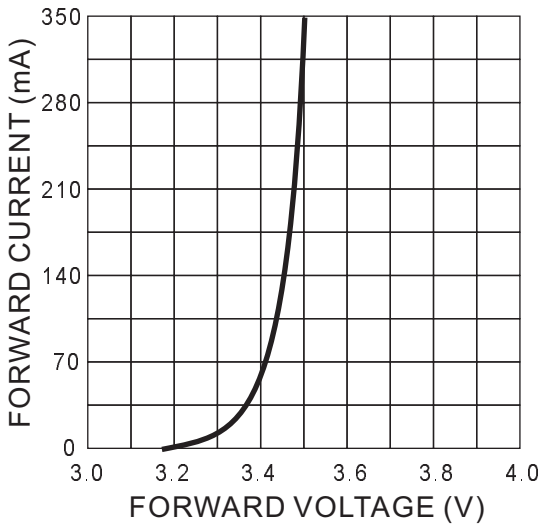

HUEY JANN ELECTRONICS INDUSTRY CO., LTD.

No.27 Line 466 Sec.2,Cannng-nan Rd. Wu-chi Town Taichung Shien, Taiwan, R.O.C.

TEL:+886-4-26393976 FAX:+886-4-26393125

TYPICAL ELECTRICAL OPTICAL CHARACTERISTICS CURVES

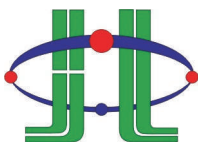
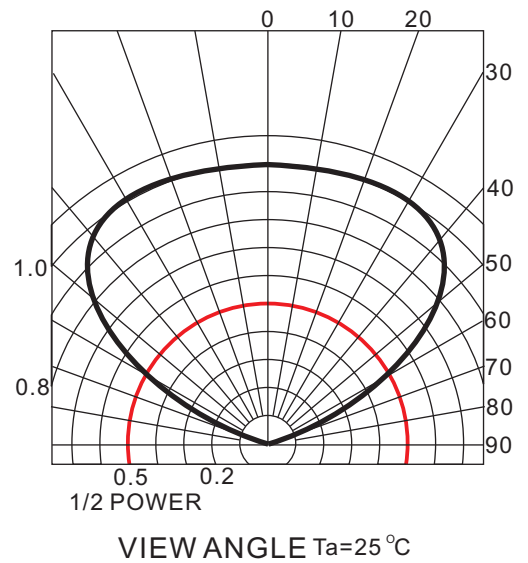
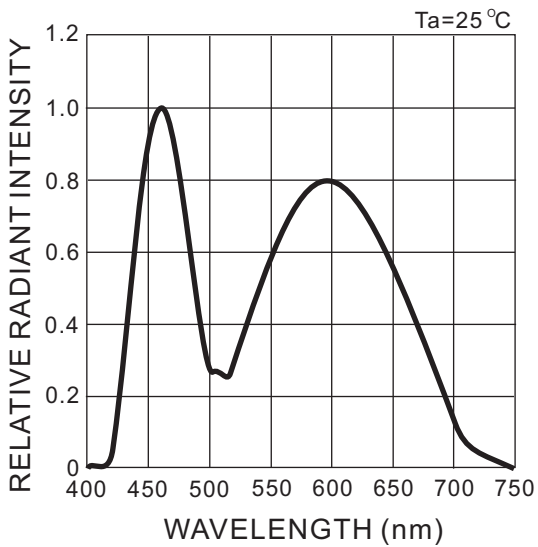
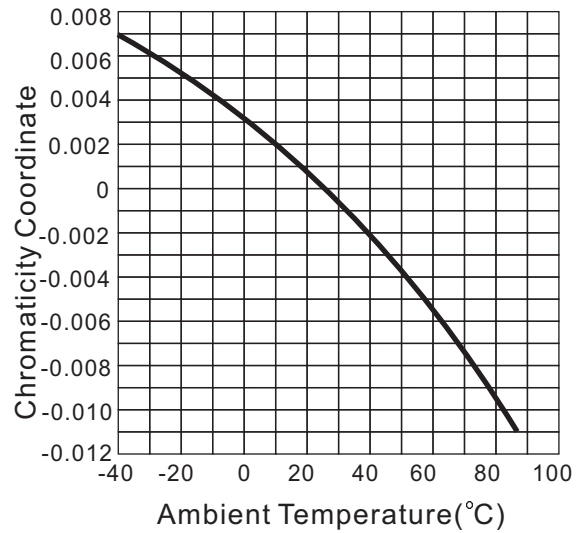
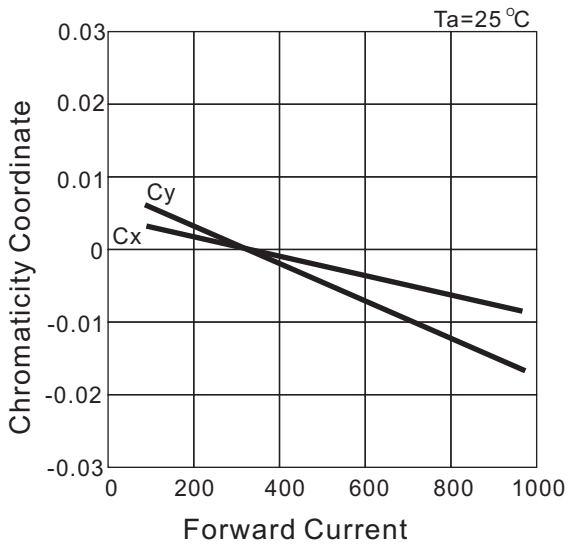

HUEY JANN ELECTRONICS INDUSTRY CO., LTD.

No.27 Line 466 Sec.2, Canng-nan Rd. Wu-chi Town Taichung Shien, Taiwan, R.O.C.

TEL:+886-4-26393976 FAX:+886-4-26393125

Brightness Bin Selection

Brightness Code		
BIN CODE	Brightness in lm	
	Minimum	Maximum
L	85	110

NOTE:

1. Test Condition at IF=350mA.
2. Brightness tolerance for each bin limit is $\pm 15\%$



HUEY JANN ELECTRONICS INDUSTRY CO., LTD.

No.27 Line 466 Sec.2,Canng-nan Rd. Wu-chi Town Taichung Shien, Taiwan, R.O.C.

TEL:+886-4-26393976 FAX:+886-4-26393125

Warm Color Bin Selection

Bin	CCT(K)	Chromaticity Coordinates				
	TYP	x	y	z	u	v
C11	3500	x	0.402	0.438	0.424	0.392
		y	0.423	0.440	0.406	0.391
C12	3640	x	0.392	0.409	0.402	0.387
		y	0.391	0.400	0.382	0.374
C13	3370	x	0.409	0.424	0.416	0.402
		y	0.400	0.406	0.389	0.382
C14	3500	x	0.387	0.416	0.410	0.383
		y	0.374	0.389	0.374	0.360
C15	3150	x	0.438	0.454	0.438	0.424
		y	0.440	0.446	0.412	0.406
C16	3150	x	0.424	0.438	0.429	0.416
		y	0.406	0.412	0.394	0.389
C17	2950	x	0.454	0.471	0.453	0.438
		y	0.446	0.451	0.416	0.412
C18	2950	x	0.438	0.453	0.444	0.429
		y	0.412	0.416	0.399	0.394
Tolerance		x ± 0.02			y ± 0.02	



HUEY JANN ELECTRONICS INDUSTRY CO., LTD.

No.27 Line 466 Sec.2,Canng-nan Rd. Wu-chi Town Taichung Shien, Taiwan, R.O.C.

TEL:+886-4-26393976 FAX:+886-4-26393125

Warm Color Bin Selection

CIE Light Color Chart

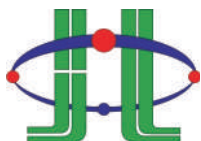
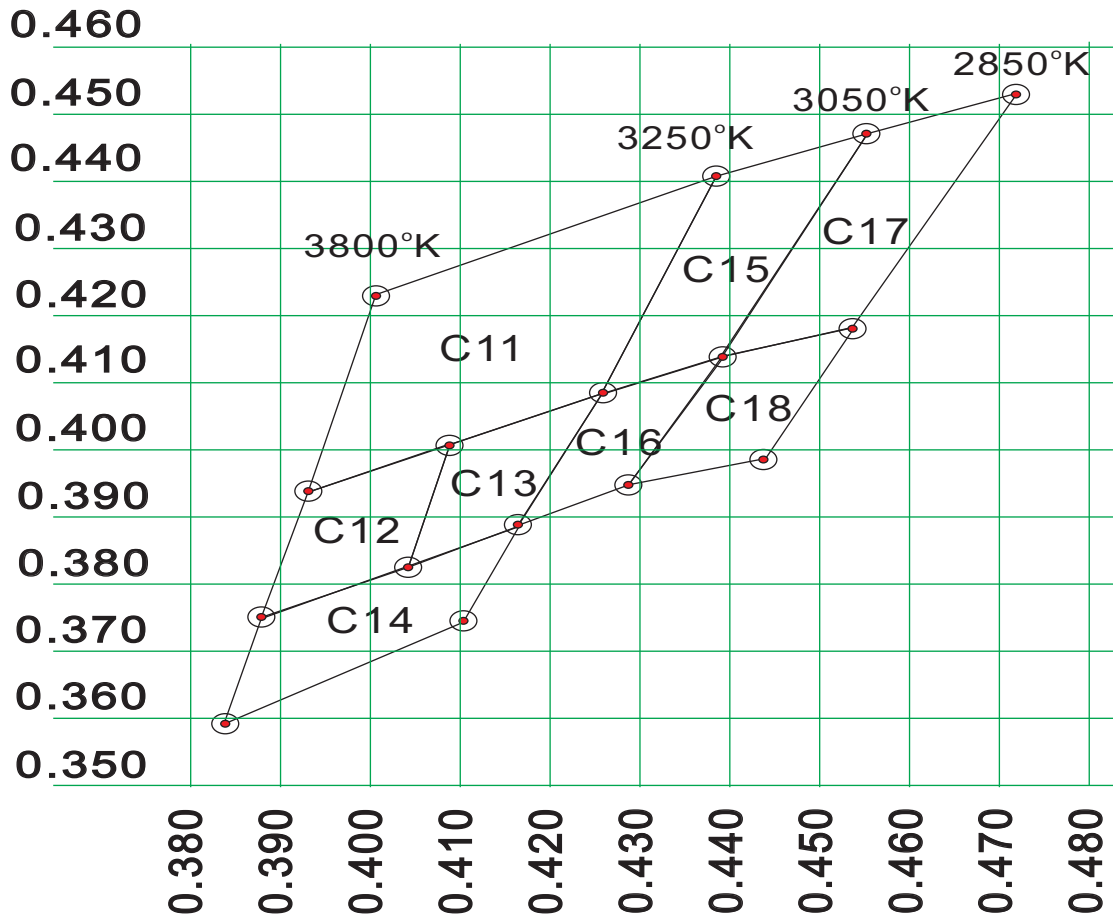

HUEY JANN ELECTRONICS INDUSTRY CO., LTD.

No.27 Line 466 Sec.2,Canng-nan Rd. Wu-chi Town Taichung Shien, Taiwan, R.O.C.

TEL:+886-4-26393976 FAX:+886-4-26393125

Package Dimension

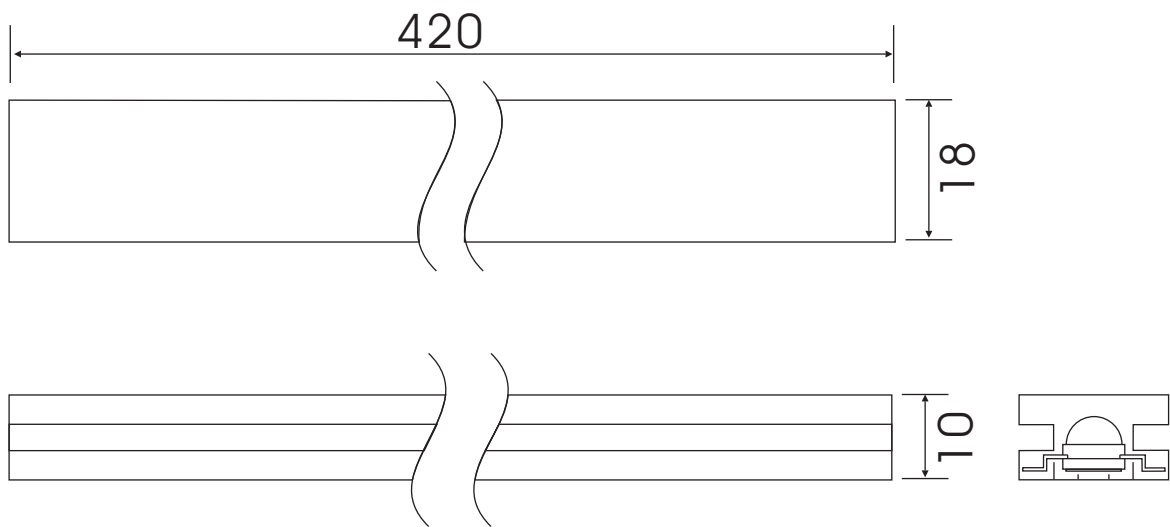

NOTE:

1. Dimensions are specified as follows: mm.
2. Tolerance is 0.3mm unless otherwise noted.
3. 50pcs emitters per tube.



HUEY JANN ELECTRONICS INDUSTRY CO., LTD.

No.27 Line 466 Sec.2,Canng-nan Rd. Wu-chi Town Taichung Shien, Taiwan, R.O.C.

TEL:+886-4-26393976 FAX:+886-4-26393125

Requirements to user

The LED products by HUEY-JANN is designed, manufactured, and sold aiming at high standard quality and reliability, however, reliability of electronic apparatus is seen as a product of reliability superior to HUEY-JANN and using status at users. From this point, HUEY-JANN requests user's for following things.

Recommended Solder Pad Design

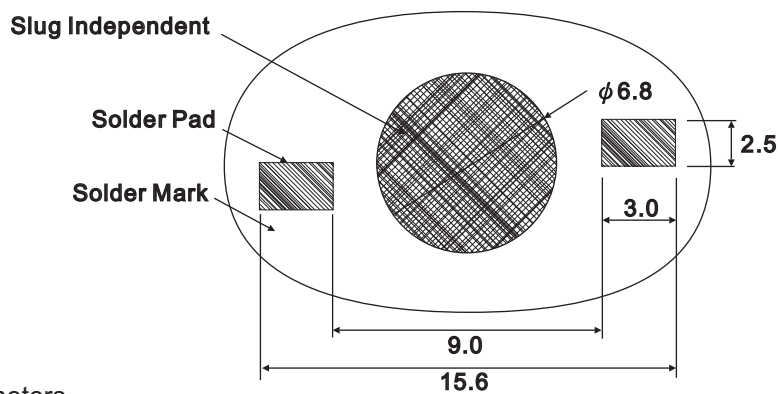

Note:

- 1.All dimensions are in millimeters.
- 2.Electrical isolation is required between Slug and Solder Pad.

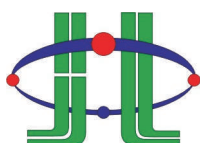

HUEY JANN ELECTRONICS INDUSTRY CO., LTD.

No.27 Line 466 Sec.2,Cannng-nan Rd. Wu-chi Town Taichung Shien, Taiwan, R.O.C.

TEL:+886-4-26393976 FAX:+886-4-26393125

Heat Plate Soldering Condition

a. Soldering Process for Solder Paste

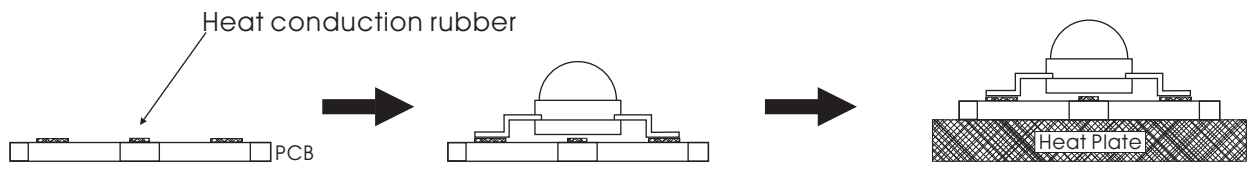

Use Solder Mask to print Solder Paste on PCB.

Place Emitter on PCB.

Put PCB on Heat Plate until Solder Paste melt.

- 1.The Solder Paste could be melted within 10 seconds.
- 2.Take out PCB out from Heat Plate within 15 seconds.

b. Soldering Process for Solder Wire

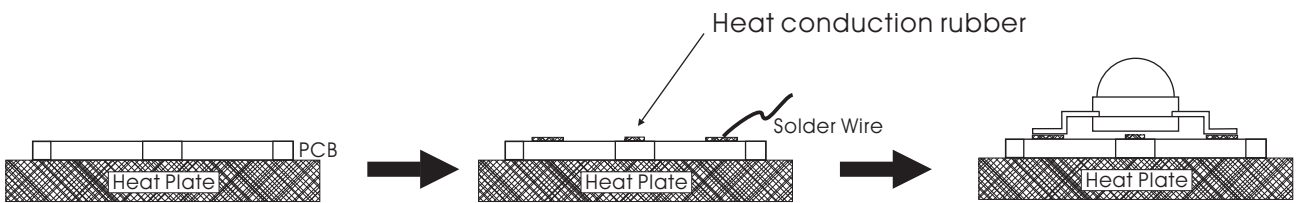

Put PCB on Heat Plate.

Place Solder Wire to the solder pad of PCB.

Put Emitter on PCB. Take the PCB out from Heat Plate within 10 seconds.

NOTE:

- 1.Heat plate temperature: 230°C max for Lead Solder and 260 °C max for Lead-Free Solder.
- 2.When soldering, do not put stress on the LEDs during heating.
- 3.After soldering, do not warp the circuit board.

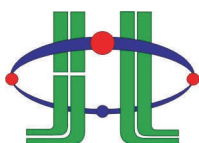

HUEY JANN ELECTRONICS INDUSTRY CO., LTD.

No.27 Line 466 Sec.2,Canng-nan Rd. Wu-chi Town Taichung Shien, Taiwan, R.O.C.

TEL:+886-4-26393976 FAX:+886-4-26393125

Soldering Process For Hot Bar

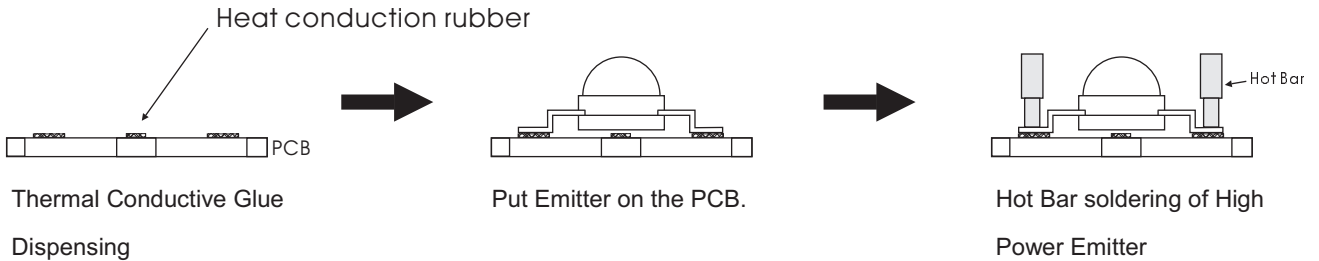

NOTE:

- 1.Hot Bar temperature: 230°C max for Lead Solder and 260 °C max for Lead-Free Solder.
- 2.When soldering, do not put stress on the LEDs during heating.
- 3.After soldering, do not warp the circuit board.

Manual Hand Soldering

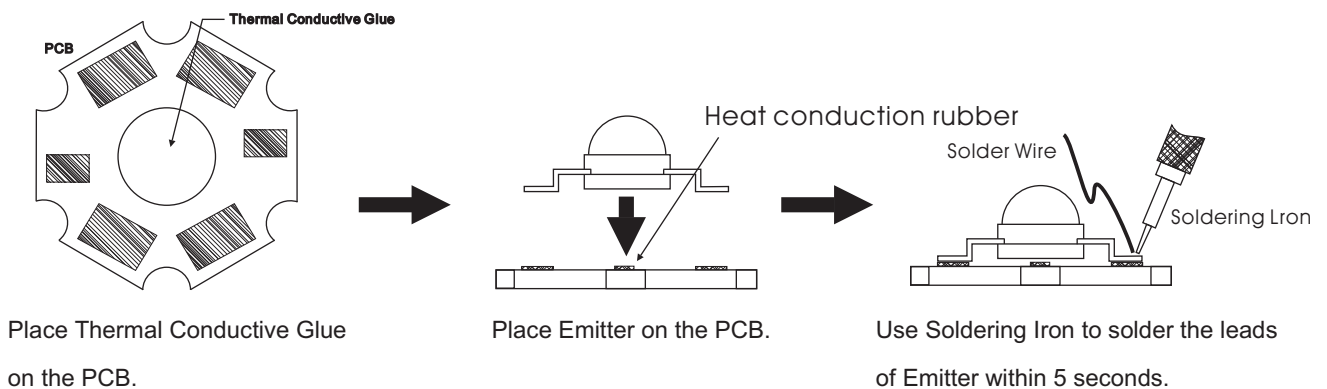

- 1.Solder tip temperature: 230°C max for Lead Solder and 260°C max for Lead-Free Solder.
- 2.Avoiding damage to the emitter or to the PCB dielectric layer. Damage to the epoxy layer can cause
- 3.Do not let the solder contact from solder pad to back-side of PCB. This one will cause a short circuit and damage emitter.

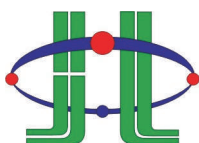

HUEY JANN ELECTRONICS INDUSTRY CO., LTD.

No.27 Line 466 Sec.2,Cannng-nan Rd. Wu-chi Town Taichung Shien, Taiwan, R.O.C.

TEL:+886-4-26393976 FAX:+886-4-26393125